



**mitsubishi
electric**

MULTIMEDIA DATA/VIDEO PROJECTORS

Changes for the Better

Our Focus: Picture-Perfect Performance



XL30U/XL25U/SL25U

XGA/3000 ANSI Lumens*

XGA/2300 ANSI Lumens*

SVGA/2600 ANSI Lumens*

*Maximum

Brighten up any presentation with these stylishly designed projectors offering impressive picture brightness and a welcome range of beneficial features.

Compact yet offering outstanding picture brightness of 3000 ANSI Lumens (maximum, XL30U) thanks to the new 0.99-inch LCD panel, these stylishly designed projectors are fully equipped for user-friendly operation and easy maintenance. Ultra-quiet operation. (only 27dB(A) in Low Lamp/Economy mode) Significantly reduced noise level, allowing the audience to concentrate on the presentation content. These models also feature a learning remote controller that can be programmed to control DVD players and video recorders connected to the projector. Other features such as disposable, rear-access air filters that help to ease servicing, 10 language menu system and 5 BNC terminals make these multimedia data/video projectors the smart choice that adds a professional touch to any presentation.

0.99-inch LCD Panel (3000 ANSI Lumens)

Compact in size yet big on performance, the XL30U incorporates a 0.99-inch LCD panel that provides a maximum brightness of 3000 ANSI Lumens. More than enough to ensure clear, sharp images even in well-lit conference rooms or halls.



sRGB

Developed to ensure standard, uniform color reproduction regardless of the type of display used, sRGB color profile technology uses independent color coordinates common to all display technologies. As a result, it helps to eliminate hue variations that occur between different display systems and more accurately matches the way colors look in real life.

To find out the details of sRGB, visit us at Global.MitsubishiElectric.com/projectors/



sRGB



Actual object



Non-sRGB

Ultra-Quiet Operation – Only 27dB(A)

Fan noise emanating from a projector can get annoying during a presentation but now that's a thing of the past. The XL30U offers ultra-quiet operation of only 27dB(A) (in Lamp Low mode) thanks to technological refinements such as the newly designed fan that is positioned at the front of the projector. This means that the audience can enjoy presentations without distraction.

XL30U **XGA**



XGA / 3000 ANSI Lumens (max.)

Impressive Picture Quality

3D CineView

Surpassing the performance of previous Line Doublers, 3D CineView improves cross coloring and virtually eliminates unwanted jagged lines for clearer still images with crisp contours. It is also useful for text such as subtitles as characters are sharper and easier to read. Along with the reproduction of beautiful, natural-looking moving images, a significant gain in video picture quality has been achieved, making it possible to recreate images with cinema-like presence.



Without 3D CineView



With 3D CineView

Natural Color Matrix™

Equipped with the third generation of Mitsubishi Electric's Natural Color Matrix™, these projector models provide vivid and accurate colour reproduction that helps to add realism and appeal to any presentation. This feature now offers TINT adjustment for PC screens in addition to its 6-axis colour correction function, providing precise and easy adjustment of both colour saturation and tone for exquisite image quality.



Without Natural Color Matrix™



With Natural Color Matrix™

RIS (Room Illumination Sensor)

The level of room illumination has a significant effect on the quality and accuracy of on-screen colour reproduction because the screen brightens as the room gets brighter and colors will appear dull. These multimedia data/video projectors offer a built-in RIS that automatically detects illumination level and colour density, adjusting mid-range colour tones as required for optimal colour reproduction and clear images under any lighting condition such as when the curtains are opened or the lights are dimmed.



Change in interior illumination brightens the room.



With RIS Automatic contrast adjustment for a clearer picture.



Without RIS Bright interior illumination dulls colour and the image.

Technological Features

2 Live Picture-In-Picture (Real Motion)

This Mitsubishi Electric original technology allows you to show two images (two motion/live images) simultaneously on screen. For example, images from two different sources (PC and video) can be shown at the same time on the main screen and PIP to provide the audience with more visual information, doubling the impact of any presentation and making it ideal for video conferencing. An increase in video processing to 60 frames/sec. provides smoother image transitions and it is also possible to zoom up on the picture.

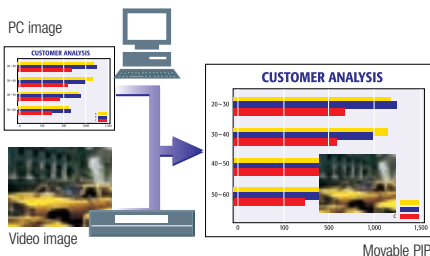

Digital-Expanded Zoom

Presentations become more professional and stimulating as Mitsubishi's Digital-Expanded Zoom makes it easy to explain and clearly see the details. Variable digital enlargement allows a section of an image to be magnified conveniently, making it ideal for use during lectures, meetings, etc.

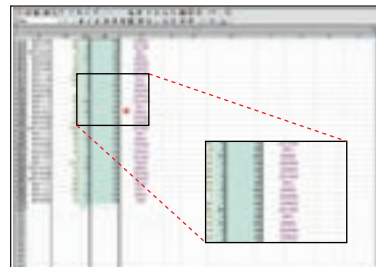

A red cross indicates the area expanded and displayed in the PIP on screen.

Digital Keystone Correction

Absolutely essential for portable projectors, Digital Keystone Correction reduces line distortion for a more natural picture, even when it is difficult to place the unit so it is perfectly perpendicular with the screen. This important feature allows you to project at an angle up to $\pm 30^\circ$ without worrying about trapezoid image distortion.

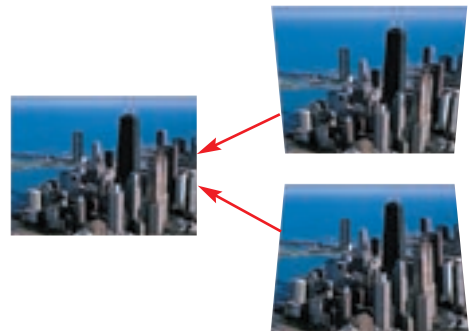

User-friendly Operation

Learning Remote Controller

To further improve operating ease, the Learning Remote Controller can be programmed to control DVD players and video recorders connected to the projector.



User Logo Display

Users can customize the projector by inserting a corporate name, logo or an image of their choice on the start up Splash or Mute screens.



10 Language OSD

The multi-language OSD makes these projectors ideal for international use, as it is capable of displaying 10 different languages including English, French, German, Spanish, Italian, Portuguese, Korean, Russian, Japanese, and Chinese. With this convenient feature, these multimedia data/video projectors are the worldwide choice for any business presentation.

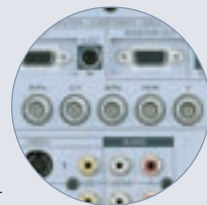

Versatile Input Terminals

Offering operating convenience for system installation, these multimedia data/video projectors are equipped with 5 BNC input terminals that allow for a variety of audio-visual and PC peripheral equipment to be connected easily including those producing component video. This kind of versatility is especially welcome when upgrading from a conventional CRT projector or creating a complete system for permanent installation.

Disposable Filters

Disposable filters eliminate the need for frequent cleaning and help to reduce maintenance time. However, it is recommended that the filters be cleaned periodically to prolong use. For added convenience, these filters can be easily accessed from the rear without removing the projector from its ceiling mount bracket.



Optional Lenses

A wide variety of optional lenses are available to suit any operating or user requirement.



OL-XL30SZ

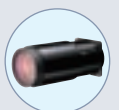

OL-XL30LZ

XL25U XGA/2300 ANSI Lumens (max.)

SL25U SVGA/2600 ANSI Lumens (max.)



- sRGB
- 3D CineView
- Natural Color Matrix™
- RIS (Room Illumination Sensor)
- 2 Live Picture-In-Picture (Real Motion)
- Digital-Expanded Zoom
- Digital Keystone Correction
- Ultra-Quiet Operation:27dB(A)
- System Operation Remote
- User Logo Display
- 10 Language OSD
- Versatile Input Terminals



- sRGB
- 3D CineView
- Natural Color Matrix™
- RIS (Room Illumination Sensor)
- 2 Live Picture-In-Picture (Real Motion)
- Digital-Expanded Zoom
- Digital Keystone Correction
- Ultra-Quiet Operation:27dB(A)
- System Operation Remote
- User Logo Display
- 10 Language OSD
- Versatile Input Terminals

Specifications

Models	XL30U	XL25U	SL25U
Display technology	1" Polysilicon panel x 3	1" Polysilicon panel x 3	1" Polysilicon panel x 3
Resolution	1024 x 768 (total 2,359,296 pixels), 600 video lines	1024 x 768 (total 2,359,296 pixels), 600 video lines	800 x 600 (total 1,440,000 pixels), 600 video lines
Brightness	3000 ANSI Lumens (Maximum)	2300 ANSI Lumens (Maximum)	2600 ANSI Lumens (Maximum)
Colour	16,770,000 colors	16,770,000 colors	16,770,000 colors
Zoom / focus	Manual control (zoom ratio: 1.3 : 1)	Manual control (zoom ratio: 1.3 : 1)	Manual control (zoom ratio: 1.3 : 1)
Picture size	40" ~ 300" (100"=3.6 m)	40" ~ 300" (100"=3.6 m)	40" ~ 300" (100"=3.6 m)
Source lamp	270W bulb	270W bulb	270W bulb
Computer compatibility	VGA® ~ UXGA® (640 x 400 ~ 1600 x 1200), True: 1024 x 768, Sync on green available	VGA® ~ UXGA® (640 x 400 ~ 1600 x 1200), True: 1024 x 768, Sync on green available	VGA® ~ SXGA® (640 x 400 ~ 1280 x 1024), True: 800 x 600, Sync on green available
Video compatibility	NTSC/NTSC 4.43/PAL (including PAL-M,N)/SECAM/PAL-60/ DVD (component) / HDTV (525p, 1080i) SCART plug (RGB +1V sync)	NTSC/NTSC 4.43/PAL (including PAL-M,N)/SECAM/PAL-60/ DVD (component) / HDTV (525p, 1080i) SCART plug (RGB +1V sync)	NTSC/NTSC 4.43/PAL (including PAL-M,N)/SECAM/PAL-60/ DVD (component) / HDTV (525p, 1080i) SCART plug (RGB +1V sync)
Input terminals	PC: mini D-sub 15 pin x 1, BNC x 5 Video1: RCA + S video x 1, Video2: RCA + BNC x 1 Audio: RCA x 2	PC: mini D-sub 15 pin x 1, BNC x 5 Video1: RCA + S video x 1, Video2: RCA + BNC x 1 Audio: RCA x 2	PC: mini D-sub 15 pin x 1, BNC x 5 Video1: RCA + S video x 1, Video2: RCA + BNC x 1 Audio: RCA x 2
Output terminals	RGB: mini D-sub 15 pin x 1	RGB: mini D-sub 15 pin x 1	RGB: mini D-sub 15 pin x 1
Communication terminals	RS-232C x 1 (DIN 8 pin), mouse terminal for USB	RS-232C x 1 (DIN 8 pin), mouse terminal for USB	RS-232C x 1 (DIN 8 pin), mouse terminal for USB
Audio speaker	3 W	3 W	3 W
Fan noise	27dB(A) - low lamp mode	27dB(A) - low lamp mode	27dB(A) - low lamp mode
Dimensions (W x H x D)	380 x 157 x 307 mm / 14.9" x 6.2" x 12.1" (including lens and feet)	380 x 157 x 307 mm / 14.9" x 6.2" x 12.1" (including lens and feet)	380 x 157 x 307 mm / 14.9" x 6.2" x 12.1" (including lens and feet)
Weight	5.9 kg / 13 lbs	5.9 kg / 13 lbs	5.9 kg / 13 lbs
Power supply	AC100 ~ 240 V / ±10 %, 50/60 Hz	AC100 ~ 240 V / ±10 %, 50/60 Hz	AC100 ~ 240 V / ±10 %, 50/60 Hz

* Windows is a registered trademark of Microsoft Corporation. * Macintosh is a registered trademark of Apple Computer Inc. * SXGA, XGA and SVGA are registered trademarks of IBM Corporation. * All brand names and product names are trademarks, registered trademarks or trade names of their respective holders.

Input and Output Terminals

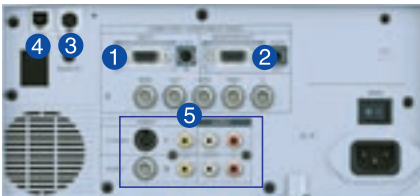

- ① PC analogue RGB input (mini D-SUB 15P)
- ② PC analogue RGB output (mini D-SUB 15P)
- ③ RS-232C input (Din-8P)
- ④ USB input
- ⑤ Video/audio input



VLT-XL30LP
Optional Lamp

Dimensions (unit: mm, inch)

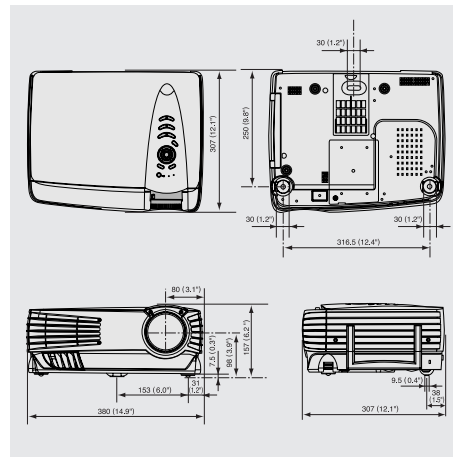

Projection distance at each screen size

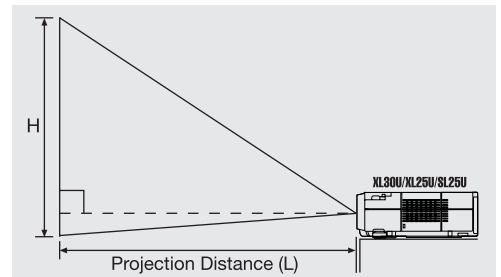

Screen Diagonal size (m)	Diagonal size (inch)	Distance from screen (L)(approximate)		Height projected	
		Maximum zoom (WIDE)	Minimum zoom (TELE)	(cm)	(inch)
1.02	40"	1.4	55"	1.8	71"
1.52	60"	2.1	83"	2.7	106"
2.03	80"	2.9	114"	3.7	146"
2.54	100"	3.6	142"	4.6	181"
3.05	120"	4.3	170"	5.5	217"
3.56	140"	5.0	198"	6.4	252"
4.07	160"	5.7	226"	7.3	288"
4.58	180"	6.4	254"	8.2	324"
5.09	200"	7.1	282"	9.1	360"
5.60	220"	7.8	310"	10.0	396"
6.11	240"	8.5	338"	10.9	432"
6.62	260"	9.2	366"	11.8	468"
7.13	280"	9.9	394"	12.7	504"
7.64	300"	10.6	422"	13.6	540"

*The above numbers are approximate, and may be slightly different from the actual measurements.

MITSUBISHI ELECTRIC AUSTRALIA
348 VICTORIA RD, RYDALMERE NSW 2116 PH: (02) 9684 7777 FAX: (02) 9684 7208

To find out more about sRGB and our projectors, visit us at
www.mitsubishi-electric.com.au
Global.MitsubishiElectric.com/projectors/